



HEIDENHAIN



**Functional
Safety**

Product Information

ECN 1325 EQN 1337

Absolute Rotary Encoders
with Tapered Shaft for
Safety-Related Applications

ID 1178026-03

ID 1178026-53

ID 1178027-01

ID 1178027-53

ECN 1325, EQN 1337

Rotary encoders for absolute position values with safe singleturn information

- 65 mm installation diameter
- 07B expanding ring coupling
- 65B tapered shaft



Functional Safety

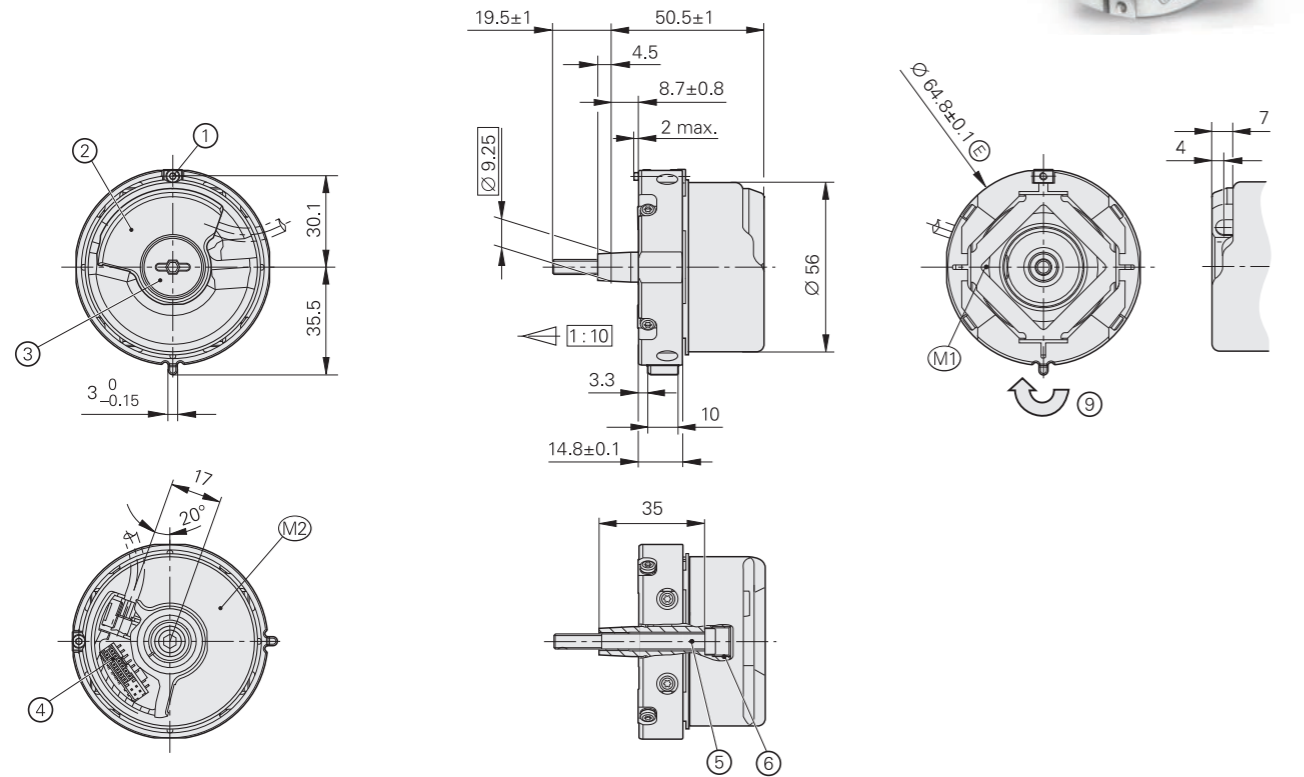

Required mating dimensions

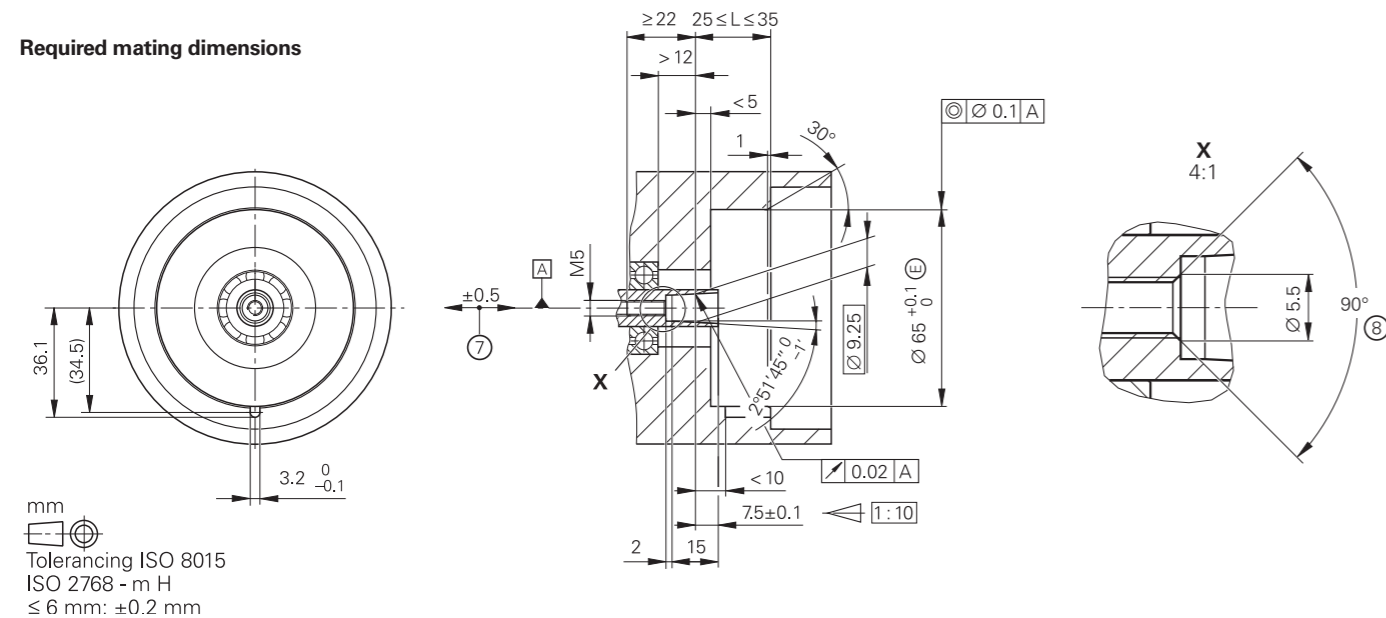

mm
Tolerancing ISO 8015
ISO 2768 - m H
≤ 6 mm: ±0.2 mm

- ☐ = Bearing of mating shaft
- M1 = Measuring point for operating temperature
- M2 = Measuring point for vibration, see D741714
- 1 = Clamping screw for coupling ring, width A/F 2, tightening torque: 1.25 Nm -0.2 Nm
- 2 = Die-cast cover
- 3 = Screw plug, width A/F 3 and 4, tightening torque: 5 Nm +0.5 Nm
- 4 = 16-pin header
- 5 = Screw: DIN 6912 - M5x50 - 08.8 - MKL, width A/F 4, tightening torque: 5 Nm +0.5 Nm
- 6 = M10 back-off thread
- 7 = Compensation of mounting tolerances and thermal expansion, no dynamic movement permitted
- 8 = Chamfer at start of thread is obligatory for material bonding anti-rotation lock
- 9 = Direction of shaft rotation for ascending position values

Specifications	ECN 1325 singleturn	EQN 1337 multiturn
Functional safety for applications with up to	As a single-encoder system for monitoring functions and closed-loop functions <ul style="list-style-type: none"> • SIL 2 as per EN 61508 (further basis for testing: EN 61800-5-2) • Category 3, PL d, as per EN ISO 13849-1:2015 Safe in the singleturn range	
PFH ¹⁾	≤ 10 · 10 ⁻⁹ (probability of dangerous failure per hour)	
Safe position ²⁾	Encoder: ±1.76° (safety-related measuring step: SM = 0.7°) Mechanical coupling: ±2° (fault exclusion for loosening of shaft and stator coupling, designed for accelerations of ≤ 300 m/s ²)	
Interface/ordering designation	EnDat 2.2 / EnDat22	
Position values per revolution	33554432 (25 bits)	
Revolutions	-	4096 (12 bits)
Calculation time t _{cal} / Clock frequency	≤ 7 μs / ≤ 16 MHz	
System accuracy at 20 °C	±20"	
Supply voltage	DC 3.6 V to 14 V	
Power consumption (max.)	At 3.6 V: ≤ 600 mW; at 14 V: ≤ 700 mW	At 3.6 V: ≤ 700 mW; at 14 V: ≤ 800 mW
Current consumption (typical)	At 5 V: 80 mA (without load)	At 5 V: 95 mA (without load)
Electrical connection	Encoder PCB connector: 16-pin, with connection for temperature sensor ³⁾	
Cable length ⁴⁾	≤ 100 m (at clock frequency ≤ 8 MHz) ≤ 20 m (at clock frequency ≤ 16 MHz)	
Shaft	65B tapered shaft Ø 9.25 mm; taper 1:10	
Permissible shaft speed	≤ 15000 rpm	≤ 12000 rpm
Starting torque at 20 °C (typical)	≤ 0.01 Nm	
Moment of inertia of rotor	2.6 · 10 ⁻⁶ kgm ²	
Angular acceleration of rotor	≤ 1 · 10 ⁵ rad/s ²	
Natural frequency of stator coupling	≥ 1800 Hz	
Permiss. axial motion of measured shaft	≤ ±0.5 mm	
Vibration 55 Hz to 2000 Hz Shock 6 ms	≤ 300 m/s ² ⁵⁾ (EN 60068-2-6); 10 Hz to 55 Hz constant over 4.9 mm peak to peak ≤ 2000 m/s ² (EN 60068-2-27)	
Operating temperature	-40 °C to 115 °C	
Trigger threshold of error message due to excessive temperature⁶⁾	125 °C (measuring accuracy of the internal temperature sensor: ±1 K)	
Relative humidity	≤ 93 % (40 °C/21 d as per EN 60068-2-78), without condensation	
Protection EN 60529	IP40 (read about "insulation" under <i>Electrical safety</i> in the <i>Interfaces of HEIDENHAIN Encoders</i> brochure; contamination through the ingress of fluids must be prevented)	
Mass	≈ 0.25 kg	
ID number	1178026-03 1178026-53 ⁷⁾	1178027-01 1178027-53 ⁷⁾

- Bold:** This preferred version is available on short notice
- ¹⁾ For use at ≤ 2000 m above sea level (≤ 6000 m above sea level upon request)
 - ²⁾ Further tolerances may arise in the subsequent electronics after position value comparison (contact mfr. of subsequent electronics)
 - ³⁾ See *Temperature measurement in motors* in the *Encoders for Servo Drives* brochure

- ⁴⁾ See the EnDat description in the *Interfaces of HEIDENHAIN Encoders* brochure
- ⁵⁾ Valid at room temperature in accordance with standard; at operating temperatures of up to 100 °C: ≤ 300 m/s²; up to 115 °C: ≤ 150 m/s² (≥ 100 °C: 10 Hz to 55 Hz constant over 2.45 mm peak to peak)
- ⁶⁾ The internal temperature evaluation is not designed with functional safety
- ⁷⁾ In collective package upon request

Mounting

The tapered shaft of the rotary encoder is slid onto the measured shaft and fastened with a central screw. It is particularly important to ensure that the positive-locking element of the stator coupling securely engages the corresponding slot in the measured shaft. A screw with material bonding anti-rotation lock must be used (see *Mounting accessories*). The stator coupling is clamped by means of an axially tightenable screw in a location hole.

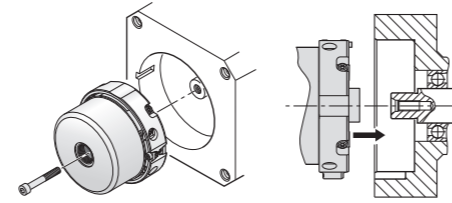

Requirements on the motor side for a safe mechanical coupling:

Mating shaft	Mating stator
Steel	Aluminum

Rotary encoders may exert a torque of up to 1 Nm on the mating shaft. The customer-side mechanical design must be made for this load.

Further information:
In addition, comply with the material specifications and other material characteristics in the *Encoders for Servo Drives* brochure (ID 208922-xx).

Mounting accessories

Screws

Screws (central screw, mounting screws) are not included in delivery and can be ordered separately.

ECN 1325, EQN 1337	Screws ¹⁾	Quantity
Central screw for shaft fastening	DIN 6912 – M5x50 – 08.8 – MKL ID 202264-54	10 or 100

¹⁾ With coating for material bonding anti-rotation lock

Please note the information on screws from HEIDENHAIN in the *Encoders for Servo Drives* brochure, under *Screws with material bonding anti-rotation lock* in the chapter *General mechanical information*.

Mounting aid

To avoid damage to the cable, use the mounting aid to connect and disconnect the cable assembly. The pulling force must be applied solely to the connector and not to the wires.

ID 1075573-01



For more mounting information and mounting aids, see the Mounting Instructions and the *Encoders for Servo Drives* brochure. The mounting quality can be inspected with the PWM 21 and ATS software.

Electrical connection: cables

EPG output cable inside the motor housing Ø 3.7 mm (with shield crimp Ø 6.1 mm); [1 × (4 × 0.06 mm ²) + 4 × 0.06 mm ²] and TPE wires 2 × 0.16 mm ² for temperature sensor		
With 16-pin PCB connector and 9-pin M23 SpeedTEC angle flange socket (male)		ID 1120948-xx ¹⁾

PUR adapter cables and connecting cables Ø 6 mm; [(2 × 2 × 0.09 mm ²) + (2 × 2 × 0.16 mm ²)]; A _P = 2 × 0.16 mm ²	8-pin M12 connector	9-pin M23 connector
With 8-pin M12 connector (female) and 8-pin M12 coupling (male) or 9-pin M23 coupling (male)		ID 1036372-xx ID 1136863-xx
With 8-pin M12 connector (female) and 15-pin D-sub connector (female)		ID 1036521-xx –
With 8-pin M12 connector (female) and 15-pin D-sub connector (male)		ID 1036526-xx –
With 8-pin M12 connector (female) and unstripped cable end		ID 1129581-xx ¹⁾ –

A_P = Cross section of the supply wires

¹⁾ Comply with the EMC requirements in the *General electrical information* in the *Interfaces of HEIDENHAIN Encoders* brochure







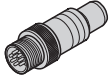

Note for safety-related applications:

- Bit error as per Specification 533095 must be documented!

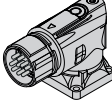
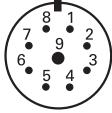
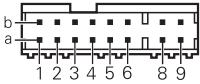
SpeedTEC is a registered trademark of TE Connectivity Industrial GmbH.

Electrical connection

Pin layout

8-pin M12 coupling or flange socket   		9-pin M23 SpeedTEC angle flange socket   								
16-pin PCB connector   16										
	Power supply				Serial data transmission				Other signals ¹⁾	
 M12	8	2	5	1	3	4	7	6	/	/
 M23	3	7	4	8	5	6	1	2	/	/
 16	1b	6a	4b	3a	6b	1a	2b	5a	8a	8b
	U_P	Sensor U_P	0V	Sensor 0V	DATA	DATA	CLOCK	CLOCK	T+²⁾	T-²⁾
	Brown/ Green	Blue	White/ Green	White	Gray	Pink	Violet	Yellow	Brown	Green

¹⁾ Only for adapter cables inside the motor housing

²⁾ Connections for external temperature sensor; evaluation optimized for KTY 84-130 (see *Temperature measurement in motors* in the *Encoders for Servo Drives* brochure)

Cable shield connected with housing; **U_P** = Power supply; **T** = Temperature

Sensor: The sense line is connected in the encoder with the corresponding power line.

Vacant pins or wires must not be used!

Note for safety-related applications: Only completely assembled HEIDENHAIN cables are qualified.

Do not modify cables or exchange their connectors without first consulting with HEIDENHAIN Traunreut!

SpeedTEC is a registered trademark of TE Connectivity Industrial GmbH.

HEIDENHAIN

DR. JOHANNES HEIDENHAIN GmbH

Dr.-Johannes-Heidenhain-Straße 5

83301 Traunreut, Germany

☎ +49 8669 31-0

FAX +49 8669 32-5061

E-mail: info@heidenhain.de

www.heidenhain.de

This Product Information document supersedes all previous editions, which thereby become invalid. The basis for ordering from HEIDENHAIN is always the Product Information document edition valid when the order is placed.



Further information:

To ensure proper and intended use, comply with the specifications in the following documents:

- Brochure: *Encoders for Servo Drives* 208922-xx
- Brochure: *Cables and Connectors* 1206103-xx
- Mounting Instructions: *ECN 1325, EQN 1337* 1345767-xx
- Technical Information: *Safety-Related Position Measuring Systems* 596632-xx
- For implementation in a safe control or inverter: *Specification* 533095-xx
- Brochure: *Interfaces of HEIDENHAIN Encoders* 1078628-xx