



# HEIDENHAIN



Preliminary  
Product Information

## **TD 110**

Tool Breakage Detector  
for Machine Tools

# TD 110 Tool Breakage Detector



## General information

The TD 110 tool breakage detector provides contact-free inspection of drill bits and end mills. It can determine whether a tool is broken off by more than 2 mm as it passes by.

## Benefits

- Maintenance-free sensor for reducing non-productive time for breakage inspection.
- Cooling lubricant and lightly contaminated tools are tolerated.
- Universally retrofittable thanks to standard interfaces for tool touch probes

## Application

The tool breakage detector can be placed in the work envelope such that it is fast and easy to reach during the tool change. The inductive sensor can detect tools as they pass by while they are spinning at their operational speed. Thanks to its rapid scanning technology, even very small tools made of HSS steel and carbide are detected.

The breakage detector can generate either a floating or an HTL switching signal. The control can evaluate this switching signal via standard instruction sets. In addition, an LED signals whether a tool has been detected.

## Example: complete breakage detection

The tool breakage detector is passed in a linear motion, and the spindle must be rotating, such as during machining. If no switching signal and thus no broken tool is registered, then the control can react accordingly.

## Retrofitting on TNC controls

The tool breakage detector can be connected to the X113 input of a PLB, UEC or UMC via the connecting cables for the TT 160 tool touch probe. If this input is already assigned, then the X112 input can be polled with a Y adapter for combined use with an SE transceiver for HEIDENHAIN touch probes.

For the operation of HEIDENHAIN controls, you receive optimal support from our Service department: cycles for breakage detection can be added via TNCremo. Please contact the HEIDENHAIN Service department:

Remote support  
service.nc-pgm@heidenhain.de  
ID 1369787-35

## Connection to other CNC controls

The HTL switching signals and the floating outputs can be used for the connection to the PLC or to other IOs of nearly every CNC control (support from the machine manufacturer may be necessary). For detailed descriptions of the interfaces, see the *Touch Probes for Machine Tools* brochure.

Specifications	TD 110
Type of mounting	Mounting holes
Breakage detection	Total breakage starting at 2 mm
Minimum tool diameter	0.4 mm
Electrical connection	8-pin M12 flange socket
Supply voltage	19.2 V to 30 V (EN 61131-2)
Output signal	HTL (S, $\bar{S}$ switching signals) floating trigger outputs (NC, NO)
Operating temperature	10 °C to 50 °C
HEIDENHAIN firmware	0.5b
Protection rating	IP68

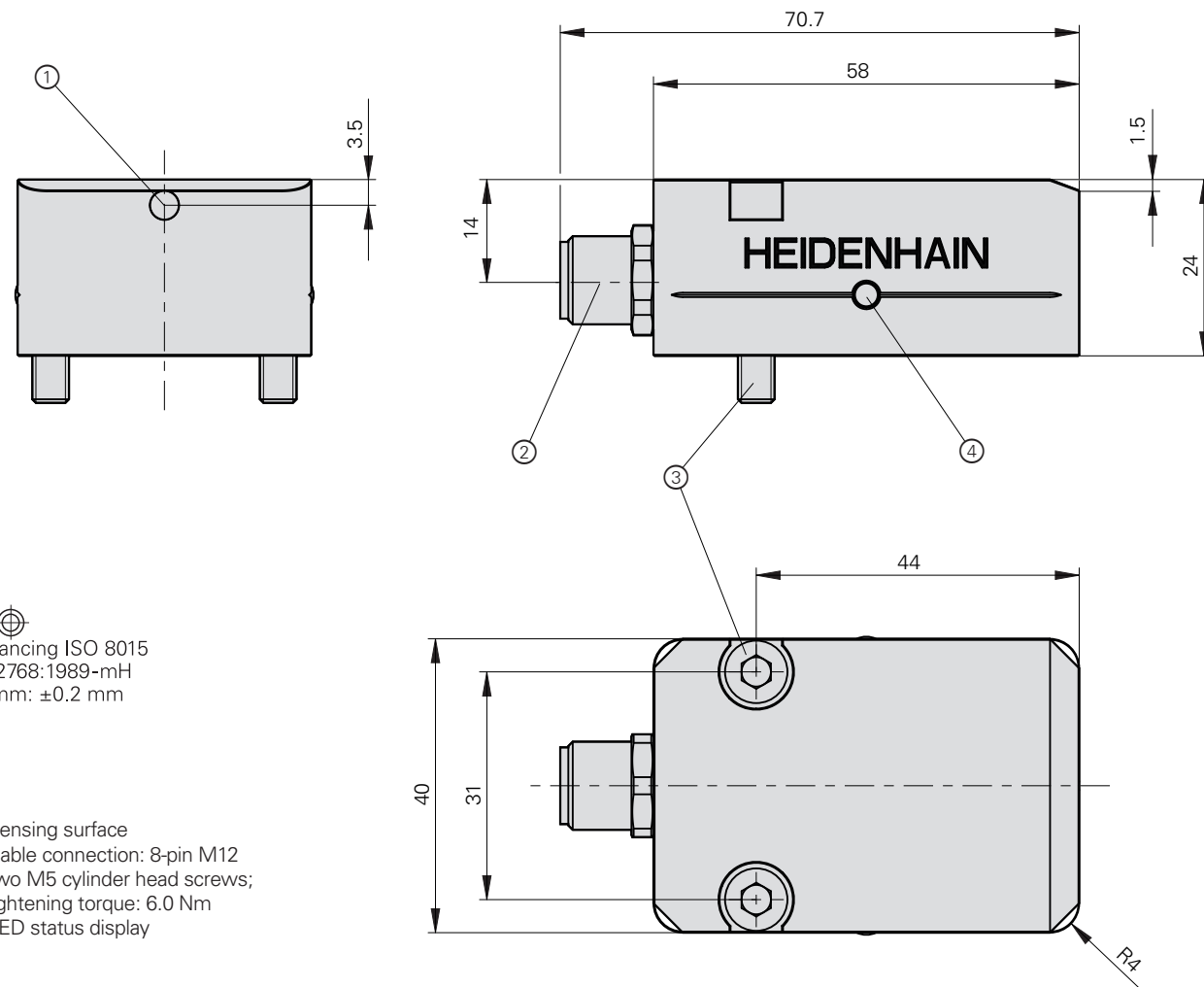





mm  
Tolerancing ISO 8015  
ISO 2768:1989-mH  
≤ 6 mm: ±0.2 mm

- 1 = Sensing surface
- 2 = Cable connection: 8-pin M12
- 3 = Two M5 cylinder head screws; tightening torque: 6.0 Nm
- 4 = LED status display

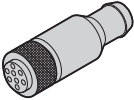
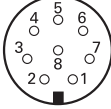
# Electrical connection

## Pin layout





<b>8-pin M12 connector (female)</b>								
								
	<b>2</b>	<b>7</b>	<b>3</b>	<b>4</b>	<b>1</b>	<b>5</b>	<b>6</b>	<b>8</b>
	<b>U<sub>P</sub></b>	<b>0V</b>	<b>S</b>	<b>S̄</b>	<b>B</b>	<b>Trigger NO</b>	<b>Trigger NC</b>	<b>Trigger 0V</b>
	Blue	Violet	Gray	Pink	White	White/Green	Yellow	Brown/Green

## Adapter cable

∅ 6 mm, 1 × (4 × 0.14 mm <sup>2</sup> ) + 4 × 0.34 mm <sup>2</sup>		
<b>Adapter cable</b> with 8-pin M12 connector (female) and 15-pin, 3-row D-sub connector (male) (PLB X113)		1070794-xx <sup>1)</sup>



<sup>1)</sup> For connection to the PLB 62xx, UEC 11x, UMC 11x

## Connecting cables

∅ 6 mm, 1 × (4 × 0.16 mm <sup>2</sup> ) + 4 × 0.34 mm <sup>2</sup>		
<b>Connecting cable</b> with 8-pin M12 right-angle connector (female) and unstripped cable end		606317-xx <sup>1)</sup>
<b>Connecting cable</b> with 8-pin M12 connector (female), partial protective armor and stripped cable end		1083190-xx <sup>1)</sup>
<b>Connecting cable</b> with 8-pin M12 right-angle connector (female) and 8-pin M12 coupling (male)		373289-xx
<b>Connecting cable</b> with 8-pin M12 connector (female) and 8-pin M12 coupling (male)		368330-xx

<sup>1)</sup> Fanuc/Siemens/Mitsubishi/Mazak

## Connecting cables

∅ 10 mm, 1 × (4 × 0.16 mm <sup>2</sup> ) + 4 × 0.34 mm <sup>2</sup>		
<b>Connecting cable</b> with 8-pin M12 connector (female) and unstripped cable end		634265-xx <sup>2)</sup>
<b>Connecting cable</b> with 8-pin M12 connector (female) and 8-pin M12 coupling (male)		660042-xx

8-pin M12 wall duct

1142270-01

# HEIDENHAIN

**DR. JOHANNES HEIDENHAIN GmbH**

Dr.-Johannes-Heidenhain-Straße 5

83301 Traunreut, Germany

☎ +49 8669 31-0

FAX +49 8669 32-5061

E-mail: info@heidenhain.de

www.heidenhain.de

This Product Information document supersedes all previous editions, which thereby become invalid. The basis for ordering from HEIDENHAIN is always the Product Information document edition valid when the order is placed.



### More information:

Comply with the requirements described in the following documents to ensure correct and intended operation:

- Brochure: *Touch Probes for Machine Tools*
- Brochure: *Cables and Connectors*

1113984-xx

1206103-xx